

Household energy storage battery

Installation Manual

Version 1.1

10/09/2024



Contents

Table of Contents

1. Product Installation.....	3
1.1. Installation Process	3
1.2. Check Before Installation.....	4
1.3. Product Appearance	5
1.4. Tools	7
1.5. Installation Environment	8
1.6. Installation Position	9
1.7. Battery Handling and Storage	12
1.8. Installing the Battery.....	13
1.9. Installing the Bus Box.....	24
2. Battery Electrical Connections	25
2.1 Instructions For Connecting Cables To External Ports.....	25
2.2 Connecting The Grounding Protection (PE)	26
2.3 Connecting Battery Cables.....	28
2.4 Connecting the bus box.....	29
2.5 RJ45 Network Interface (Inverter Comms Connection).....	31
3. Product Maintenance Information.....	33
3.1 Wiring of the Isolation Device	33
3.2 Monitoring	35
3.3 Device Protection Function.....	36
3.4 Maintenance and Cleaning Information	37

1. Product Installation

Precautions

	<p>Do not install INNO-A-5kW Series on flammable materials. Do not install INNO-A-5kW Series in places where flammable and explosive materials are stored.</p>
<p style="text-align: center; background-color: red; color: white;">Danger</p>	
	<p>The case may be hot when the battery is operating, so do not install the INNO-A-5kW Series where you may inadvertently come into contact with them.</p>
<p style="text-align: center; background-color: yellow;">Be Careful</p>	
	<p>The transport and movement of the battery takes into account the weight of the INNO-A-5kW Series. Choose the appropriate mounting location and surface. At least two people are required to move/mount the battery.</p>
<p style="text-align: center; background-color: blue; color: white;">Watch out</p>	

1.1. Installation Process

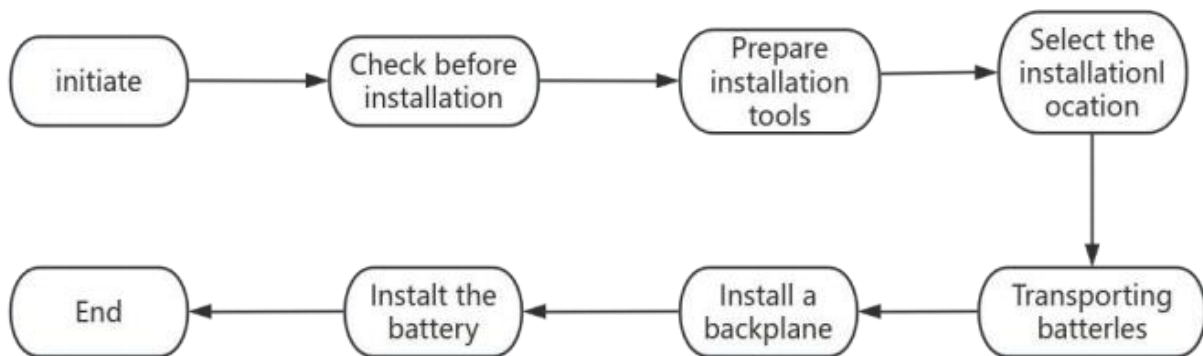

Figure 1-1 Schematic diagram of installation process

1.2. Check Before Installation



Inspection of Outer Packaging



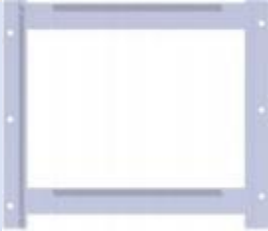

Packaging materials and components may incur damage during transit. Before installing the battery, inspect the outer packaging for any signs of damage, such as holes, cracks, or tears. If you find any damage to the battery, do not open the packaging and contact your dealer immediately. For best results, it is recommended to remove the packaging material within 24 hours before installation.

Verify Contents Against Delivery List

Once the battery is unpacked, check that all items listed on the delivery list are present. If any items are damaged or missing, please contact your dealer promptly.

Before installation, please ensure that the packaging and accessories are intact. The following accessories are included:

Name	Main role	Image
Wall mounting brackets	For securely mounting the battery pack to the wall.	
Upper cover	Provides protection and enhances aesthetics.	
① Negative terminal	Connect the negative power cable here.	

② Positive terminal	Connect the positive power cable here.	
Left foot board	Fixed platform providing bottom support.	
Right foot board	Fixed platform providing bottom support.	
Fixed feet	Ensures the battery pack remains stationary.	
RJ45 connector	Data communication port connector	

1.3. Product Appearance

The INNO-A-5kW Series battery undergoes thorough inspection prior to packaging and shipping. It is essential to ensure that INNO-A-5kW Series batteries are not positioned upside-down during transportation and installation.

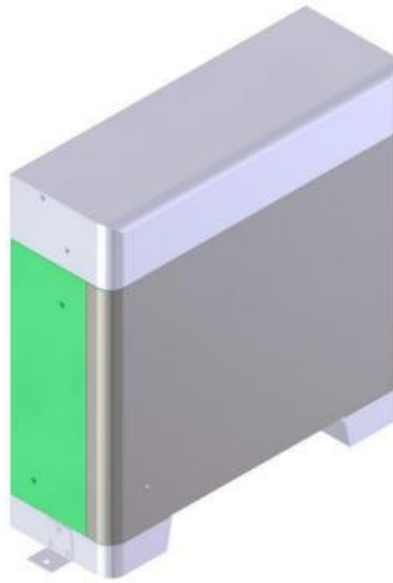

Figure 1-2 INNO-A-5kW Series Unit

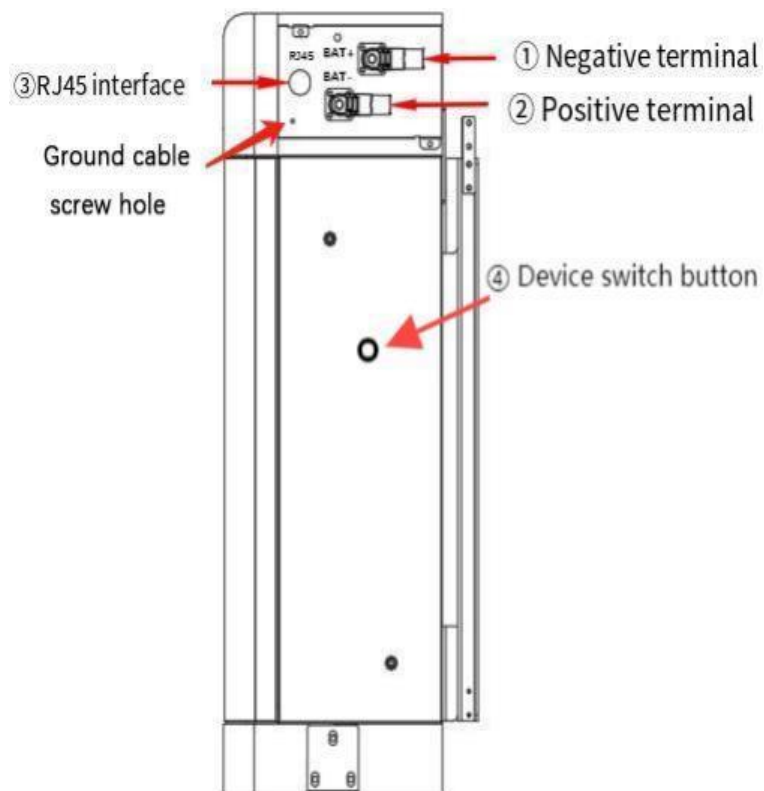

Figure1-3 Structure of the INNO-A-5kW Series

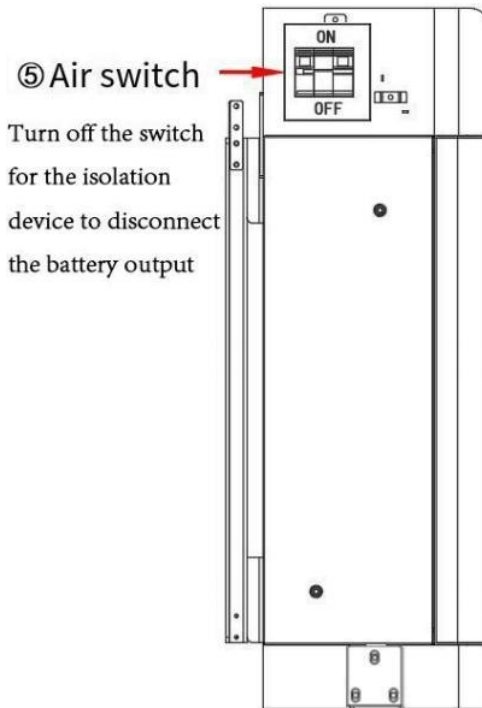









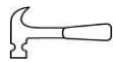

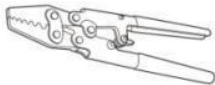

Figure1-4 Structure of the INNO-A-5kW Series

1.4. Tools

Prepare the Tools Needed for Installation and Electrical Connections.

Table 1-1: Tools Required for Installation and Electrical Connections

	<p>Level measuring instruments</p>		<p>Flat-mouth screwdriver</p>
	<p>Wire clamps</p>		<p>Measuring tape</p>
	<p>Allen wrench</p>		<p>Torque wrench</p>

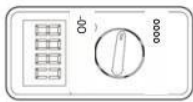
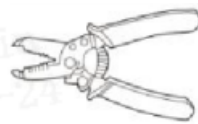
	Wrench		Hammer
	Power drill		Phillips screwdriver
	Wire crimping pliers		Marker pen
	Multimeter		Wire strippers

1.5. Installation Environment

1. Location Selection

Choose a dry, clean area that facilitates easy installation.

2. Ambient Temperature Range

- Ambient Temperature: -20°C to 60°C

3. Relative Humidity

- 0% to 95% (non-condensing)

4. Ventilation

- Ensure the INNO-A-5kW Series battery is installed in a well-ventilated space.

5. Proximity to Flammable Materials

- Keep flammable and explosive materials away from the INNO-A-5kW Series battery.

6. Installation Height

- Maximum installation height: 2000 meters above sea level.

7. Clearance Requirements

- Maintain a distance of at least 600mm from any outlet, floor, ceiling/roof.
- Keep at least 600mm away from windows that ventilate habitable rooms or any vertical building ventilation devices.

- Ensure a distance of 600mm from heat sources, air conditioning units, or any equipment unrelated to the pre-assembled battery system.
- Maintain a minimum clearance of 900mm below any items listed in (6), (7), and (8).

8. Prohibited Locations

- Do not install in ceiling, wall cavities, roofs, stairs, or under passages.
- Avoid installation on evacuation or escape routes.

Note:

A pre-assembled battery system is considered a source of ignition. Therefore, it must not be installed within a hazardous area as defined in AS/NZS 3000:2018, Section 7, unless the installation complies with AS/NZS 60079.14. For other electrical installations, the pre-assembled battery system must not be positioned in hazardous areas for gas cylinders containing heavier-than-air gases and gas relief vent terminals, as outlined in AS/NZS 3000:2018, Section 4.

1.6. Installation Position

When determining the proper location for the INNO-A-5kW Series battery installation, consider the following requirements:

1. Outdoor Installation

The battery can be installed outdoors in cool environments, provided it is protected from direct sunlight.

2. Suitable Locations

Appropriate installation locations include:

- Garages
- Storage rooms
- Dedicated battery system rooms
- Verandas or balconies

3. Protection from Damage

The pre-assembled battery system should be safeguarded against mechanical damage, environmental factors, and other external influences. If the chosen location may expose the system to potential damage (e.g., in a garage where vehicles are present), this should be considered during installation.

4. Clearance in Corridors

If the battery system is installed in a corridor or lobby, ensure a minimum clearance of at least 1 meter from the system to facilitate safe exits.

5. Temperature Requirements

The installation location must maintain ambient temperatures within the manufacturer's specified limits, avoiding extremes that could harm the system.

6. Protection Against Environmental Factors

Ensure the installation site offers protection against potential damage from:

- Water and high humidity
- Dust and pests
- Solar radiation (direct sunlight)

Additionally, avoid localized or general heating by maintaining distance from heat sources such as sunlight, generators, steam pipes, hot water systems, air conditioners, and space heaters. Keep combustible materials away from these heat sources.

Note:

Refer to the Australian electrical installation requirements AS/NZS 3000 and the Australian battery storage installation standard AS/NZS 5139 for further guidance on installation practices.

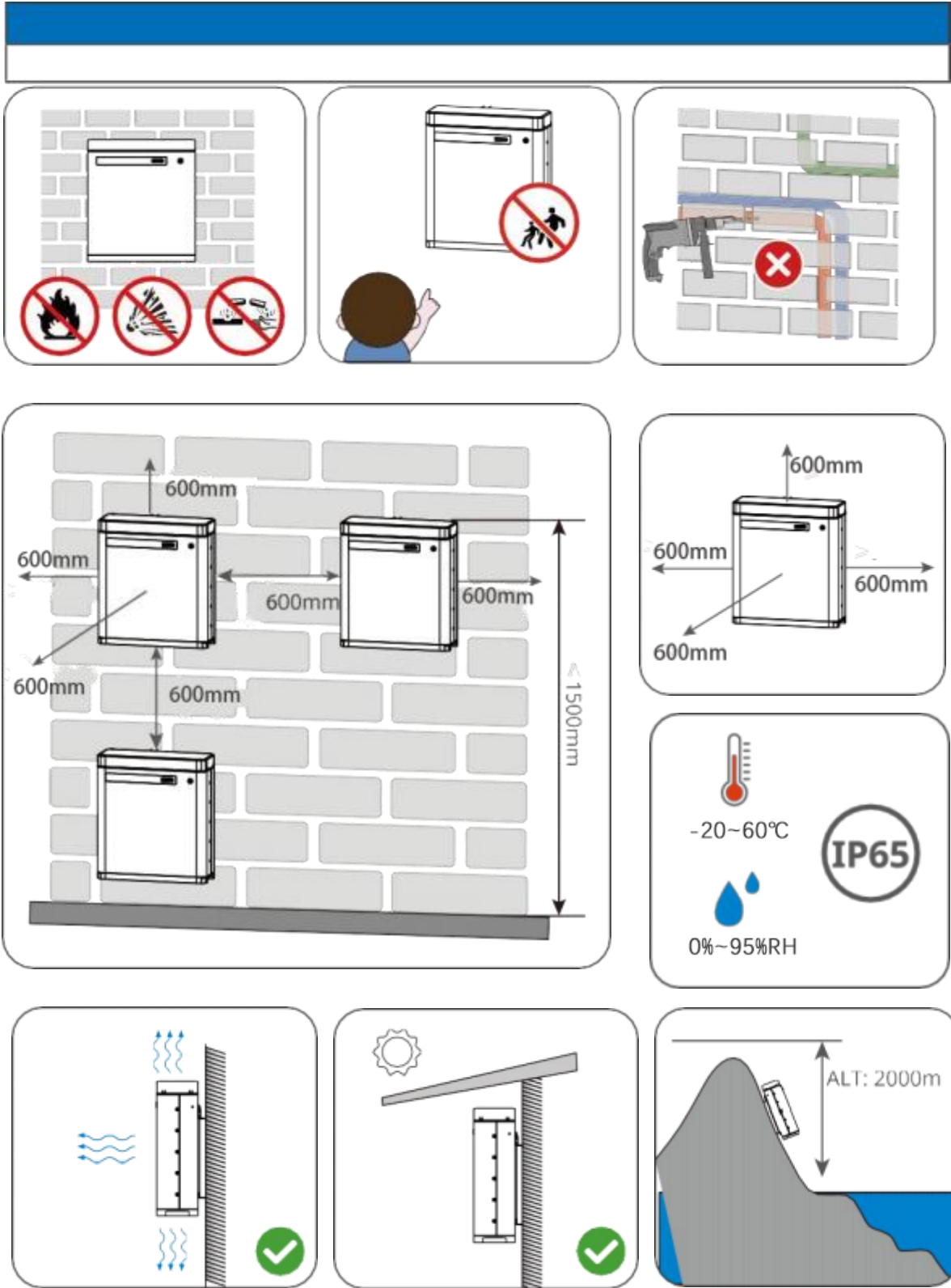

Figure 1-5 Installation position

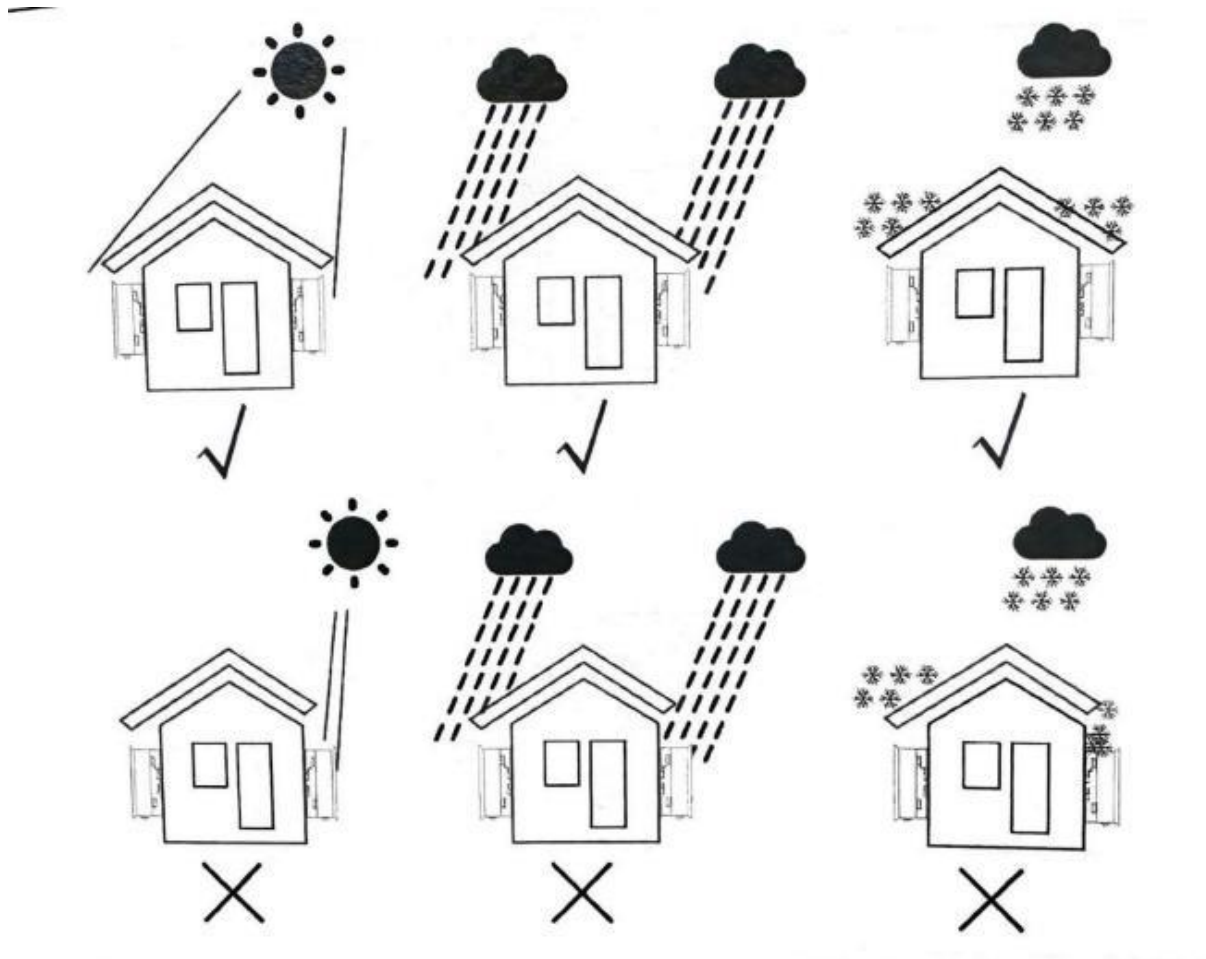

Figure 1-6 Installation Environment Diagram

The pre-assembled battery system must not be installed in restricted locations as specified in AS/NZS 5139, clause 5.2.2.)

1.7. Battery Handling and Storage

Carefully remove the battery from the packaging and transport it horizontally to the designated installation position. Open the outer packing case, then use both hands to lift the battery out of the packaging and move it to the specified location.

Storage Conditions:

The battery package should be stored in an environment with an ambient temperature range of

0°C to 35°C and a relative humidity of 65±20%.

	<p>The battery is heavy; please ensure proper balance while handling to prevent the battery from falling and causing injury to the operator.</p> <p>When placing the battery on the ground, use foam or paper underneath to avoid damaging the casing.</p>
<p>Watch out</p>	

1.8. Installing the Battery

Floor Mount Installation (Cannot Be Mixed With Wall Mount)

Note: It is essential to drill holes in hard surfaces only; do not drill into dirt or soft ground.

Installation Steps:

Step 1:

Position the battery pack in the desired location and use a marker to mark the floor and walls, as illustrated in Figure 1-7.

Step 2:

Remove the battery pack and wall mount pack. Use a power drill to drill holes (13mm diameter, 65mm depth) at the marked locations, as shown in Figure 1-8.

Step 3:

Secure the hangings to the wall with M10 expansion screws, tightening to a torque of 10 N·m, as depicted in Figure 1-9.

Step 4:

Attach the foot block to the battery pack using M5 hex socket screws. Next, secure the battery pack labeled "BAT3" to the ground with M10 expansion screws, then stack "BAT2" and "BAT1" in sequence, as shown in Figure 1-10.

Step 5:

After properly connecting the battery pack to the inverter using the power and communication cables, press the power button. Once the battery communicates successfully with the inverter, install the four protection boards onto the three battery packs one by one, as shown in Figure 1-11.

Step 6:

Building a Green Tomorrow
InnoEnergy.com.au

The installation is now complete, as illustrated in Figure 1-12.

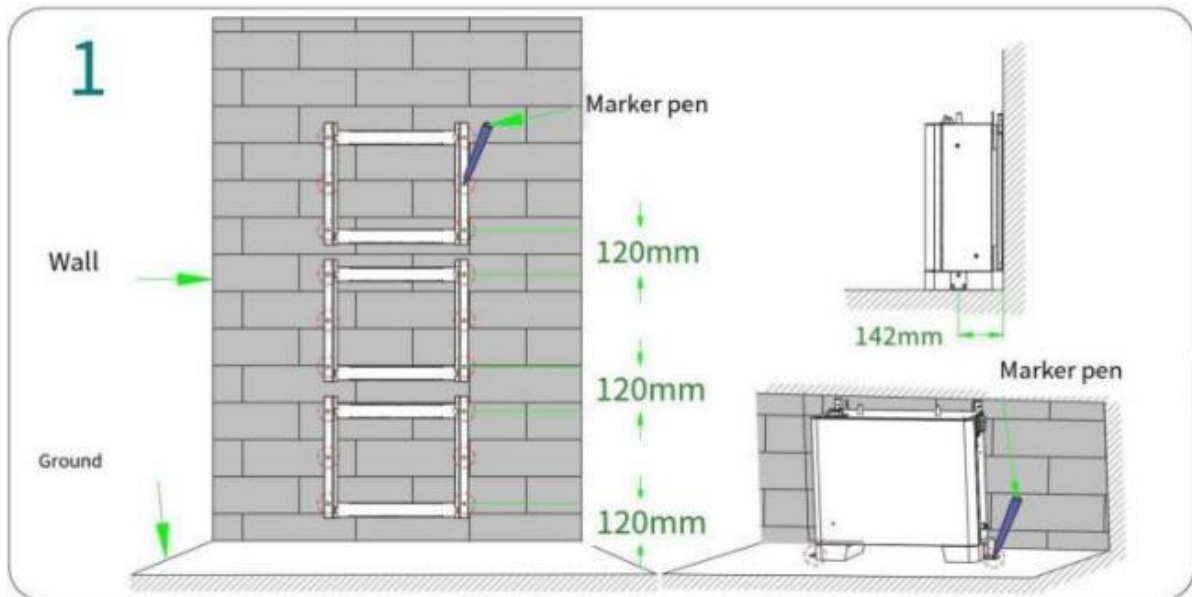

Figure 1-7: Step 1

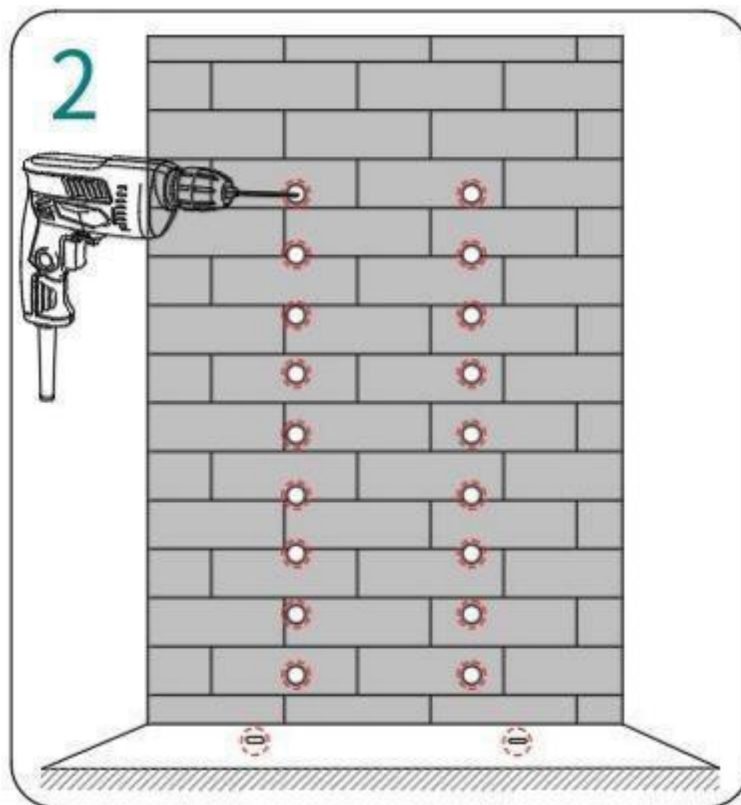

Figure 1-8: Step 2

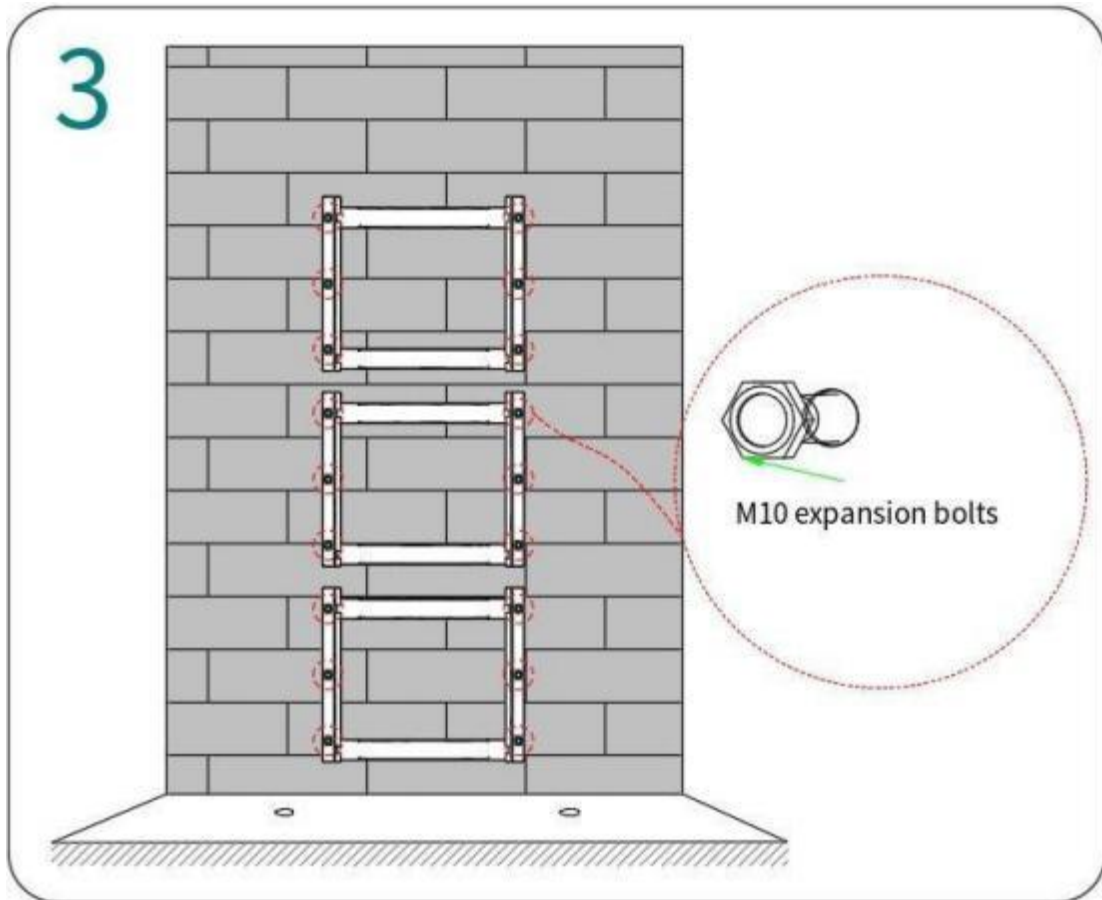

Figure 1-9: Step 3

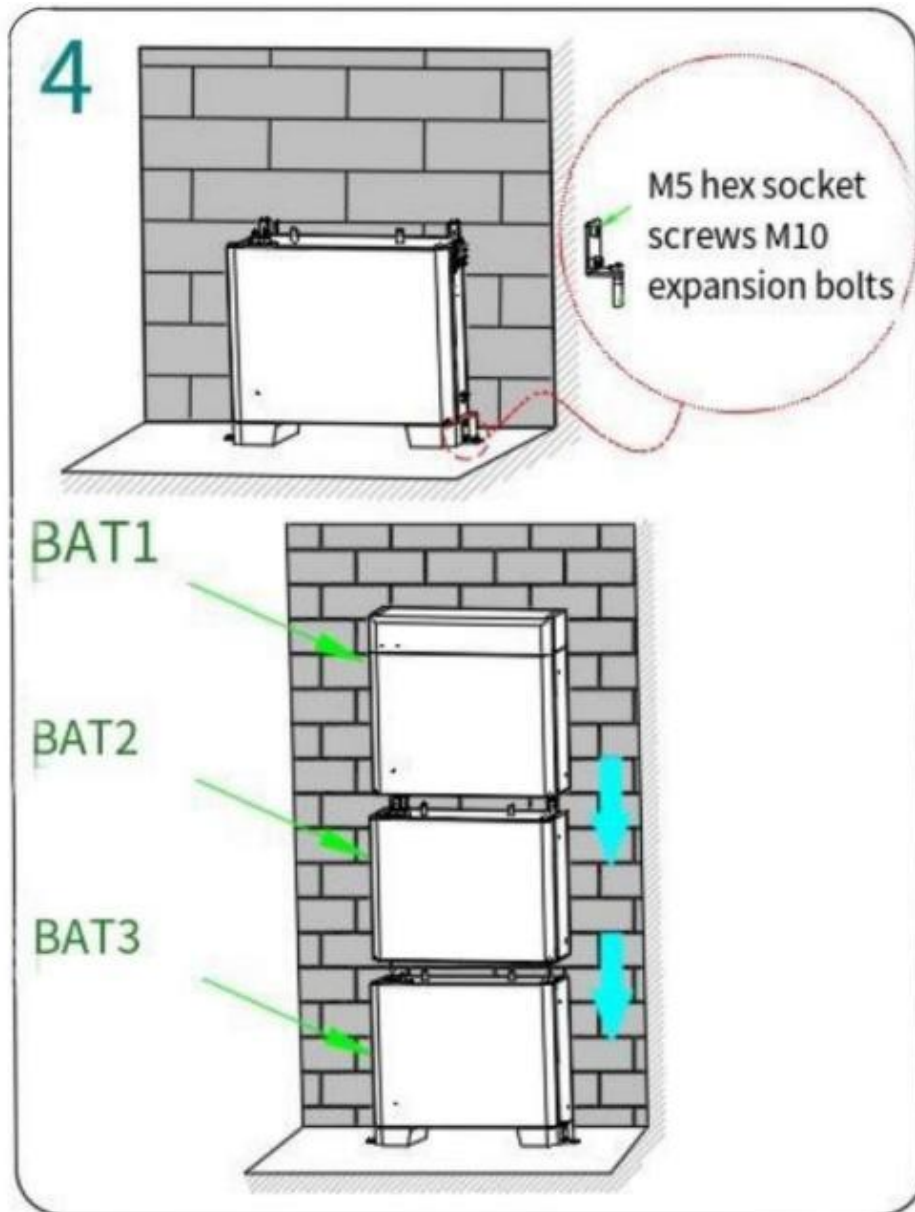

Figure 1-10: Step 4

Note: Follow the serial number on the battery for installation (each battery is numbered) as shown.

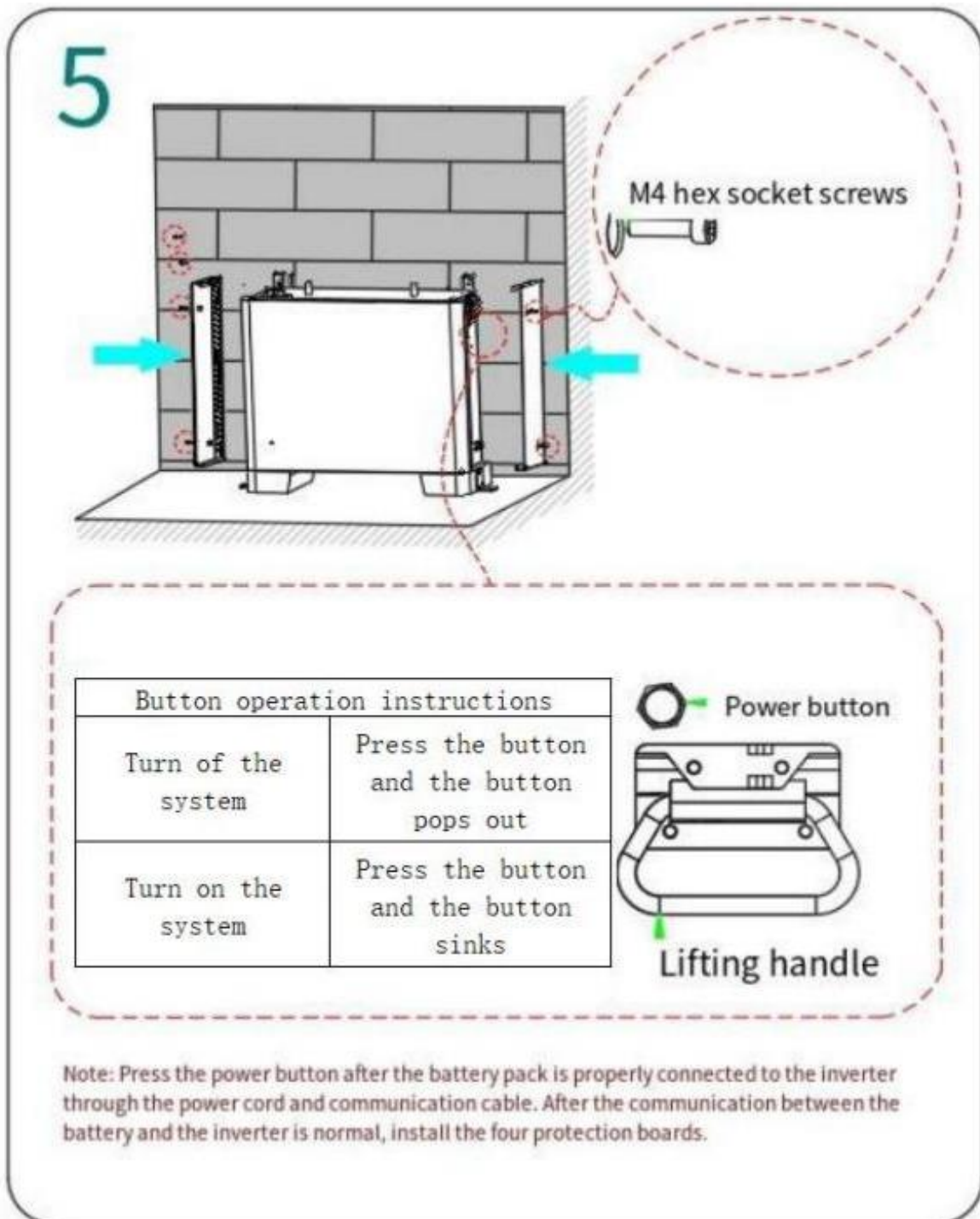

Figure 1-11: Step 5

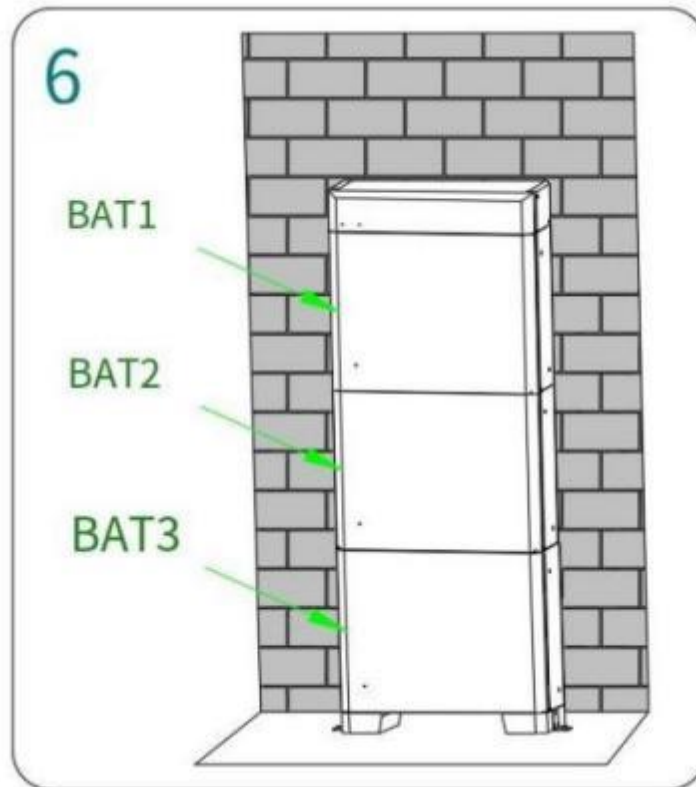

Figure 1-12: Step 6

Wall Mount Installation (Cannot Be Mixed With Floor Mount)

Installation Steps:

Step 1:

Position the wall panel against the wall. Once you confirm that the installation is secure, use a marker to mark the holes, then remove the wall hangings, as shown in Figure 1-13.

Step 2:

Using a hammer drill, create holes (13mm diameter, 65mm depth) in the marked locations on the wall, as illustrated in Figure 1-14.

Step 3:

Secure the pendant to the wall with M10 expansion bolts, tightening to a torque of 10 N·m, as shown in Figure 1-15.

Step 4:

Hang the battery pack labeled "BAT3" on the wall first, then stack "BAT2" and "BAT1" in sequence, as depicted in Figure 1-16.

Step 5:

After connecting the battery pack to the inverter using the power and communication cables, press the power button. Once the communication between the battery pack and the inverter is established, install the three protection boards for the battery packs one by one, as shown in Figure 1-17.

Step 6:

The installation is now complete, as illustrated in Figure 1-18.

Note:

The three columns of battery packs should be arranged from left to right in order of serial number, from smallest to largest, as shown in Figure 1-19.

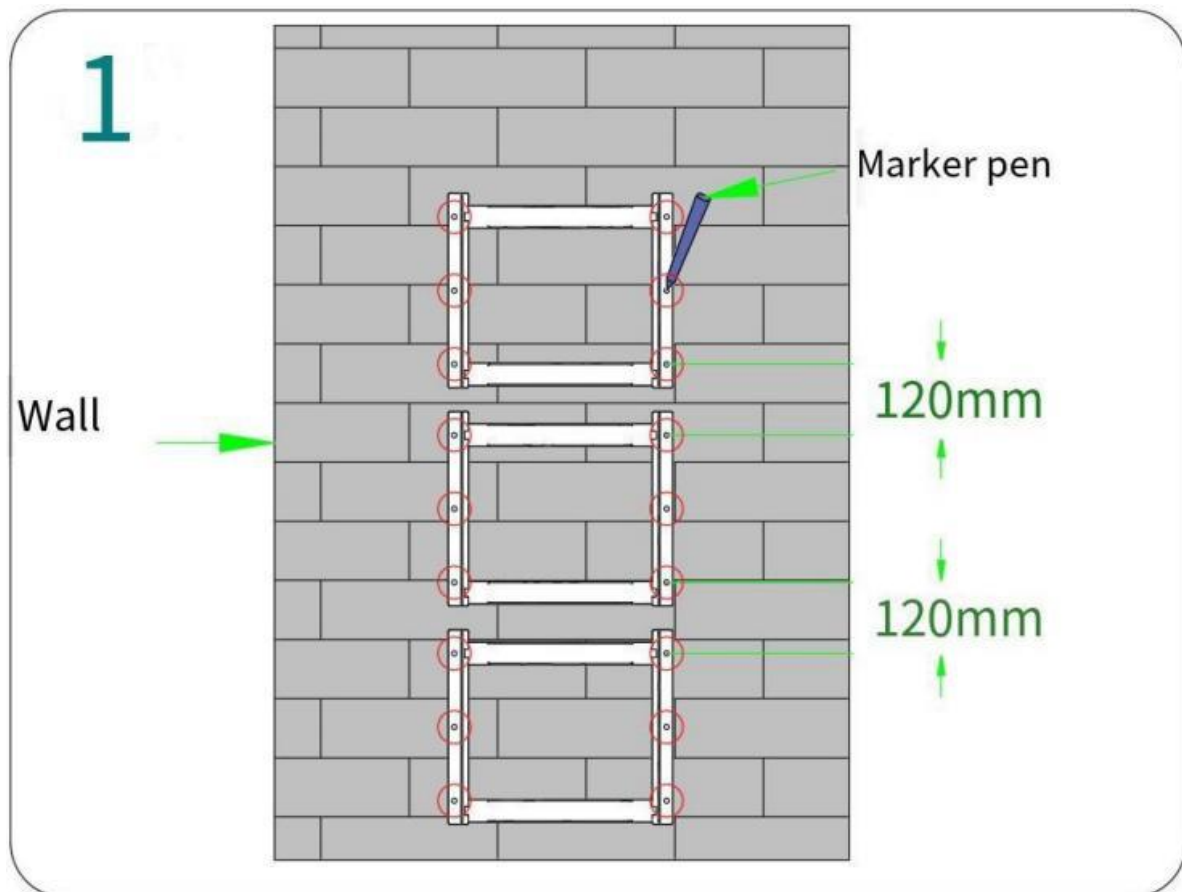

FIGURE 1-13: STEP 1

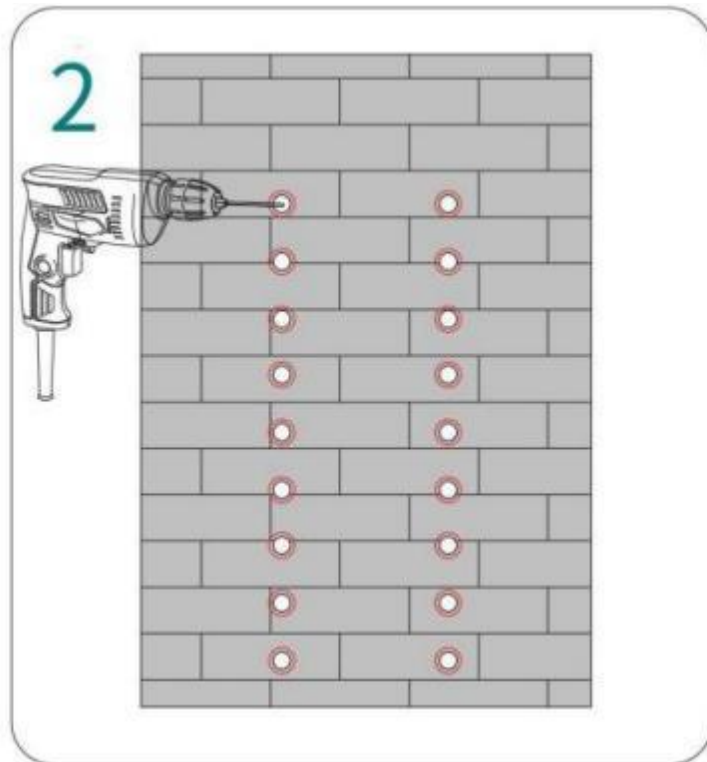

Figure 1-14: Step 2

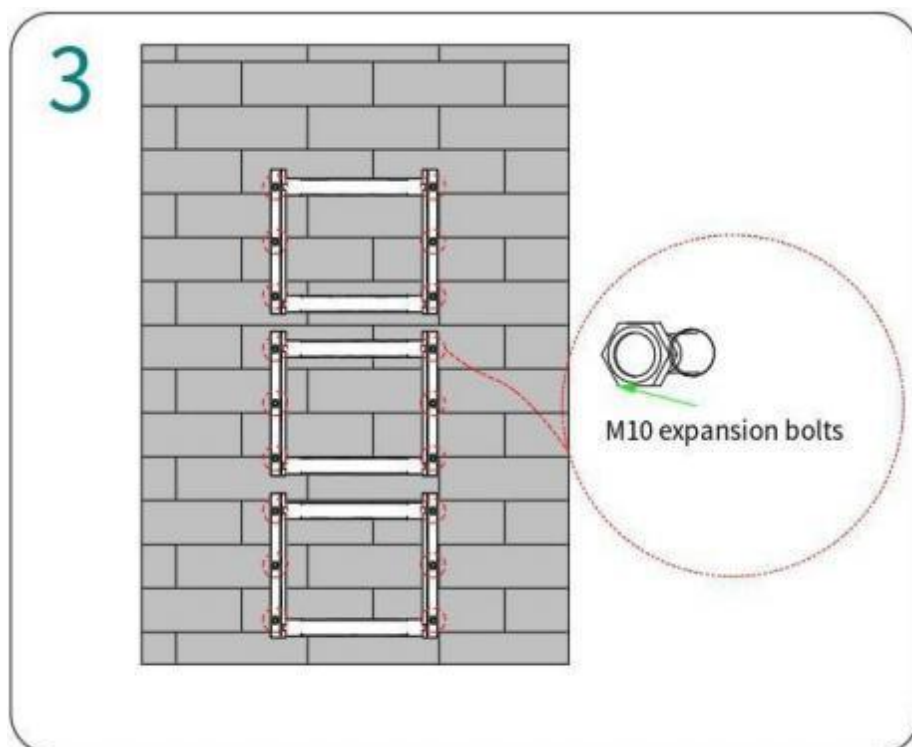

Figure 1-15: Step

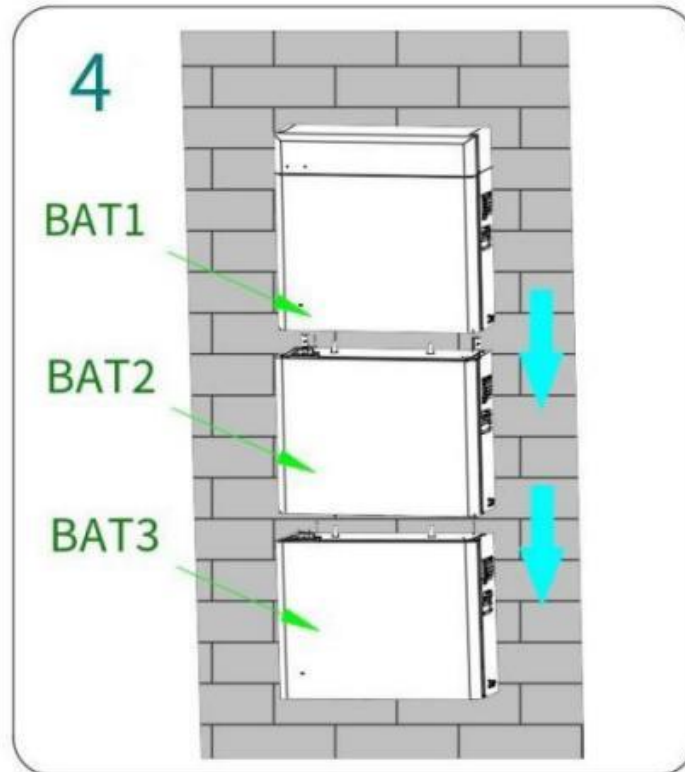

FIGURE 1-16: STEP 4

Note: Follow the serial number on the battery for installation (each battery is numbered) as shown.

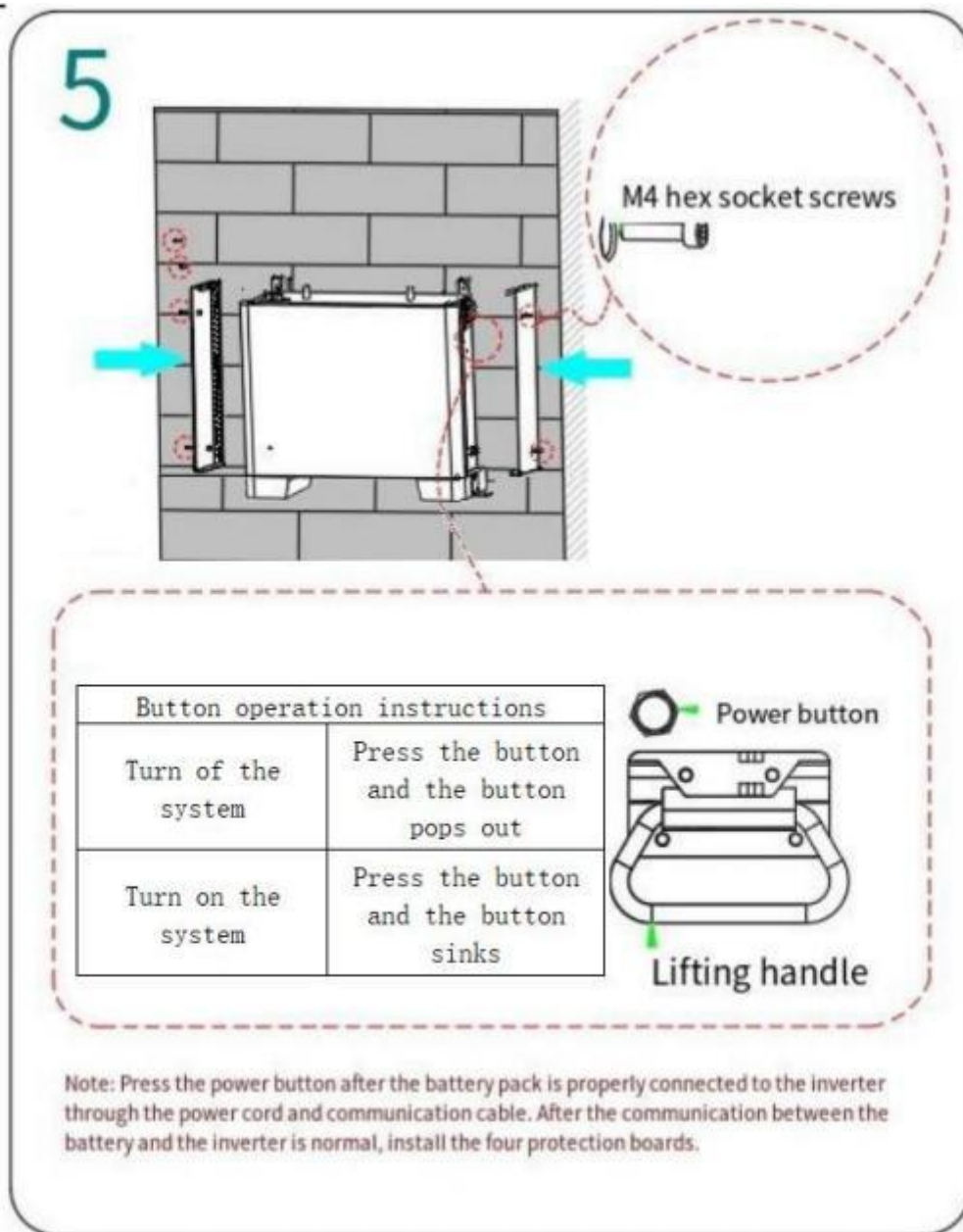

Figure 1-17: Step 5

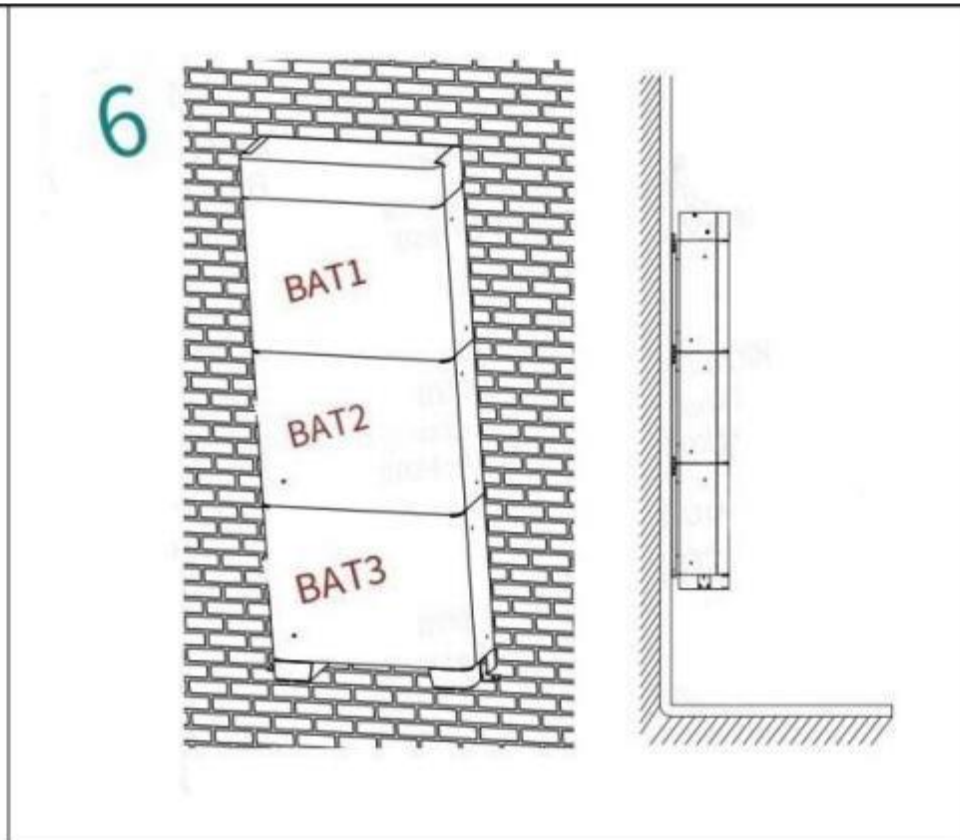

Figure 1-18: Step 6



FIGURE1-19: Step 7

Note: There are communication pair plug-ins below the base, so a wall mount also requires a base.

1.9. Installing the Bus Box

Step 1:

Position the bus box on top of the wall and use a marker to mark the corresponding holes, as indicated by ① in the following picture.

Step 2:

Remove the bus box and drill a hole (13mm diameter, 65mm depth) at the marked location using an electric drill.

Step 3:

Insert the M10 expansion screws into the four drilled holes.

Step 4:

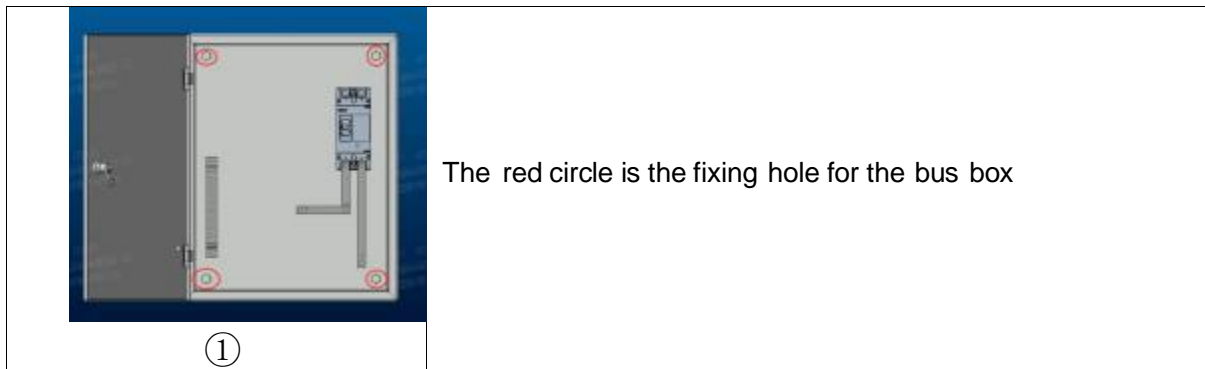

Align the bus box with the corresponding holes and tighten the screws using a wrench.

Installation Complete.





2. Battery Electrical Connections

Ensure that both the AC and DC sides are de-energized before proceeding with installation and maintenance.

	<p>Ensure that qualified electrical engineers are responsible for the installation and maintenance of the batteries.</p>
<p>Watch Out</p>	<p>When working on high-voltage or high-current systems, it is essential to wear rubber gloves, protective clothing, safety glasses, and protective boots.</p>
	<p>Before connecting the DC terminal, ensure that the battery air switch is turned off. Do not connect the DC power line while the air switch is in the "on" position.</p>
<p>Danger</p>	

2.1 Instructions For Connecting Cables To External Ports

Ports	Description
	<p>Orange Terminal: The positive battery terminal, which connects to the positive terminal of the bus box.</p> <p>Black Terminal: The negative battery terminal, which connects to the negative terminal of the bus box.</p>
	<p>Communication Jack: Use a network cable to connect to this jack for communication purposes.</p>

2.2 Connecting The Grounding Protection (PE)

Prepare a ground cable (recommended: $\geq 5\text{mm}$ yellow-green outdoor power cable).

Step 1:

Use a wire stripper to remove the insulation from the ground cable to an appropriate length (1), as illustrated in Figure 2-1.

Step 2:

Insert the stripped wire core into the crimping area of the OT terminal and firmly compress it with the crimping pliers (2 in Figure 2-1). The recommended OT terminal is OT M5, and the ground cable diameter should be $\geq 6\text{mm}^2$.

Step 3:

Secure the OT terminal using M4 screws, as shown by (3) in Figure 2-1. The recommended torque for securing the screws is $2\text{N}\cdot\text{m}$.

Note 1: L3 represents the distance between the insulated terminal surface of the cable and the rear section of the terminal conductor crimping area. L4 indicates the length of the conductor extending beyond the terminal crimping area.

Note 2: The cavity formed after crimping should completely cover the cable conductor, ensuring a tight bond between the cable conductor and the terminal.

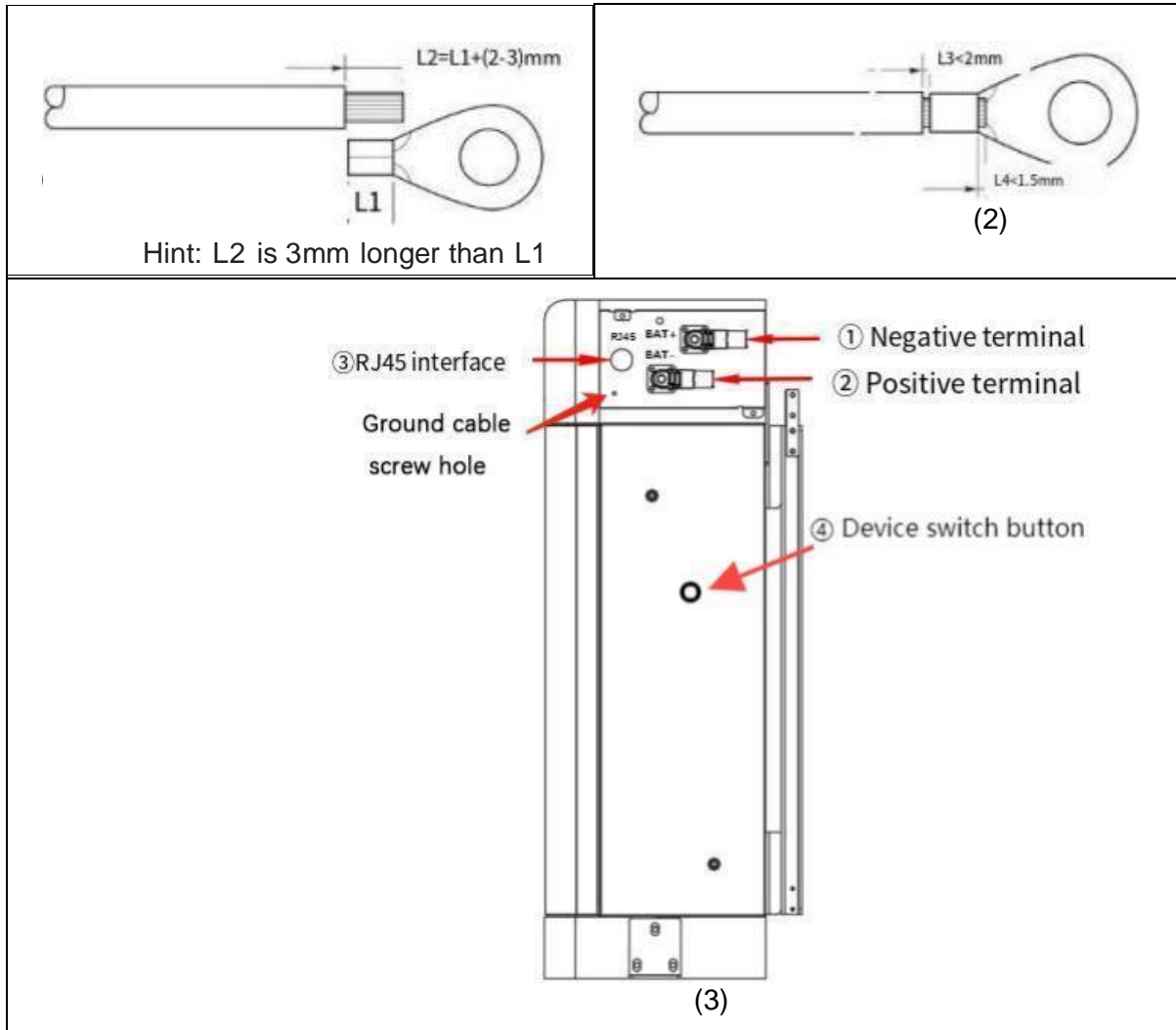



Figure 2-1 Grounding cable connection

2.3 Connecting Battery Cables

	
Watch out	<p>Before connecting the positive and negative terminals, ensure that the air switch is in the off position and the battery is powered down.</p>

1. Connect one end of the 2-meter positive power line to the terminal indicated as ② in the figure below.
2. Connect one end of the 2-meter negative power line to the terminal indicated as ① in the figure below.

Note: Repeat these two steps for all three batteries.

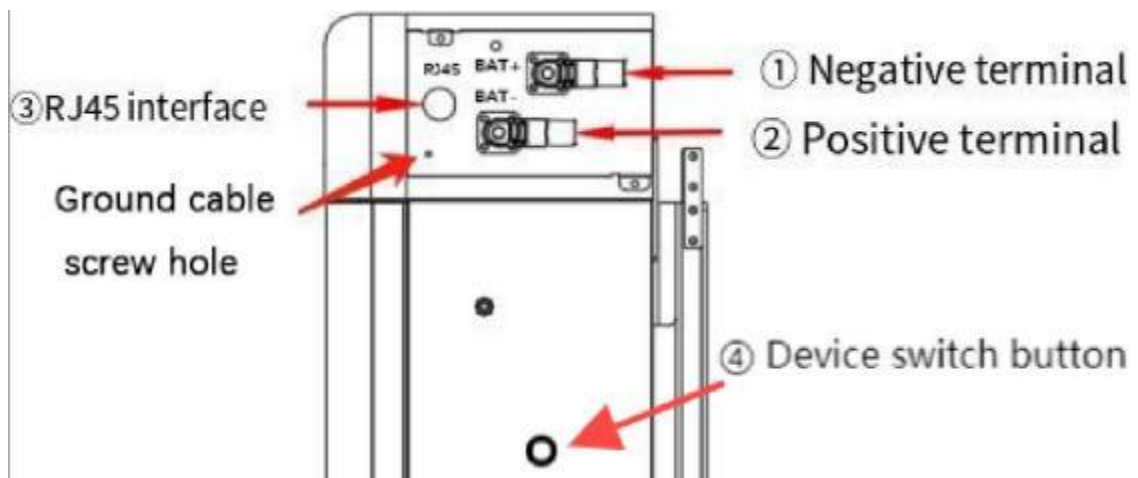

Figure 2-2 Connection port view



Positive terminal



Negative terminal

2.4 Connecting the bus box



Watch out

Before connecting the positive and negative power lines to the copper bar of the bus box, ensure that the air switch is in the off position and that the battery is powered down.



Peep terminal, this terminal should be connected to the bus-box copper bar.

Connect the Positive Terminal:

1. Step 1: Connect the upper end of the positive power cable from the battery string (with the peep terminal) to the **positive copper bar** of the bus box using **M6 screws**.

Connect the Negative Terminal:

2. Step 2: Connect the upper end of the negative power cable from the battery string (with the peep terminal) to the **negative copper bar** of the bus box using **M6 screws**.

Note: Repeat the above two steps for all three battery packs, ensuring that the positive and negative terminals of each battery pack are connected to their respective positive and negative copper bars in the bus box.

Connection Diagram

- The connection diagram should illustrate how the upper ends of the bus box are linked to the inverter, ensuring a clear representation of the wiring setup.

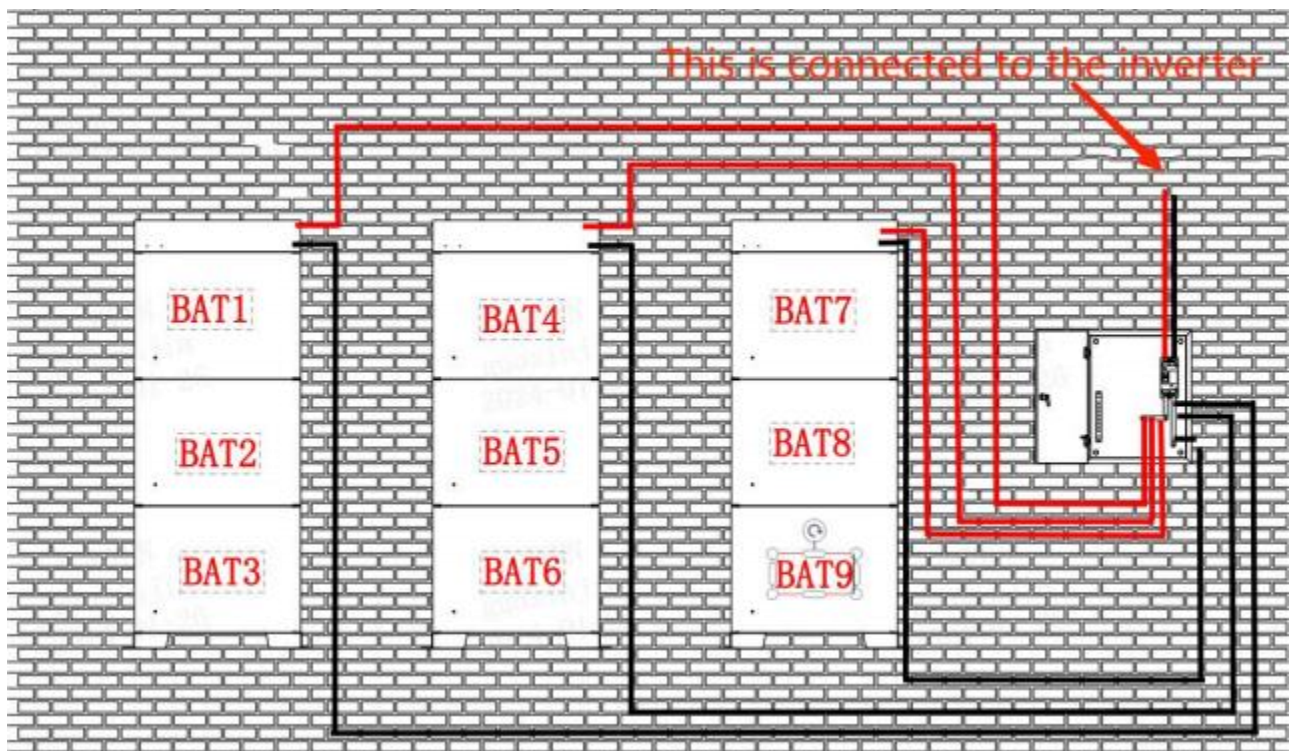

Figure 2-3

2.5 RJ45 Network Interface (Inverter Comms Connection)

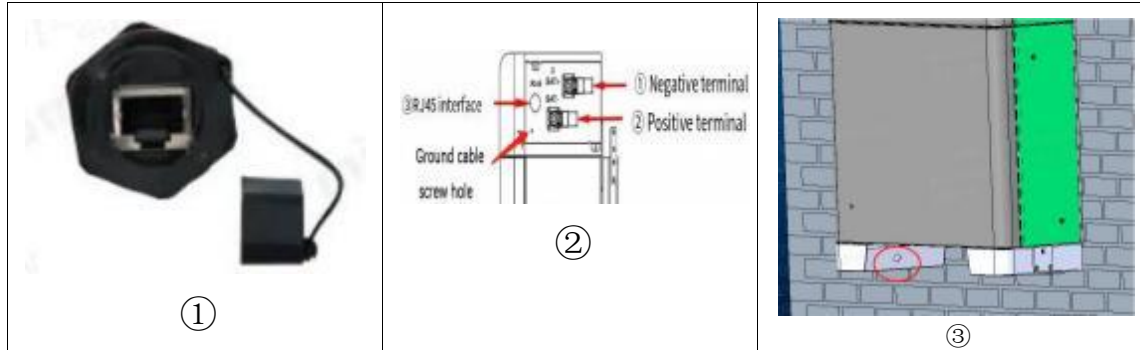

Figure 2-4 RJ45 network ports

Connections for communication between battery packs and external connections for communication with inverters.

Step 1: Connect the First Column to the Inverter

- **Action:** Connect one end of the network cable to the **first column junction box** of the battery pack (refer to the indicated point in the figure).
- **Completion:** Connect the other end of the network cable to the **RJ45 network interface** of the inverter.

Step 2: Connect the First and Second Columns

- **Action:** Locate the **RJ45 network connector** (highlighted in the red circle in Figure ③) under the base of the **first column** of the battery pack.
- **Completion:** Insert a network cable into this connector and connect the other end to the **RJ45 network connector** on the **junction box of the second column** of the battery pack.

Step 3: Connect the Second and Third Columns

- **Action:** For the **second column** of the battery pack, find the **RJ45 network connector** (highlighted in the red circle) under its base.

- **Completion:** Insert a network cable here and connect the other end to the **RJ45 network connector** in the **terminal box of the third column** of the battery pack, following the same procedure as in Step 2.

Visual Overview

- Make sure to refer to the figures for visual guidance on where to connect the cables. This will help ensure that each connection is made correctly and securely.

Final Note

- Double-check all connections to ensure they are tight and secure to prevent any communication issues. Proper installation is critical for the functionality of the communication network between the battery packs and the inverter.

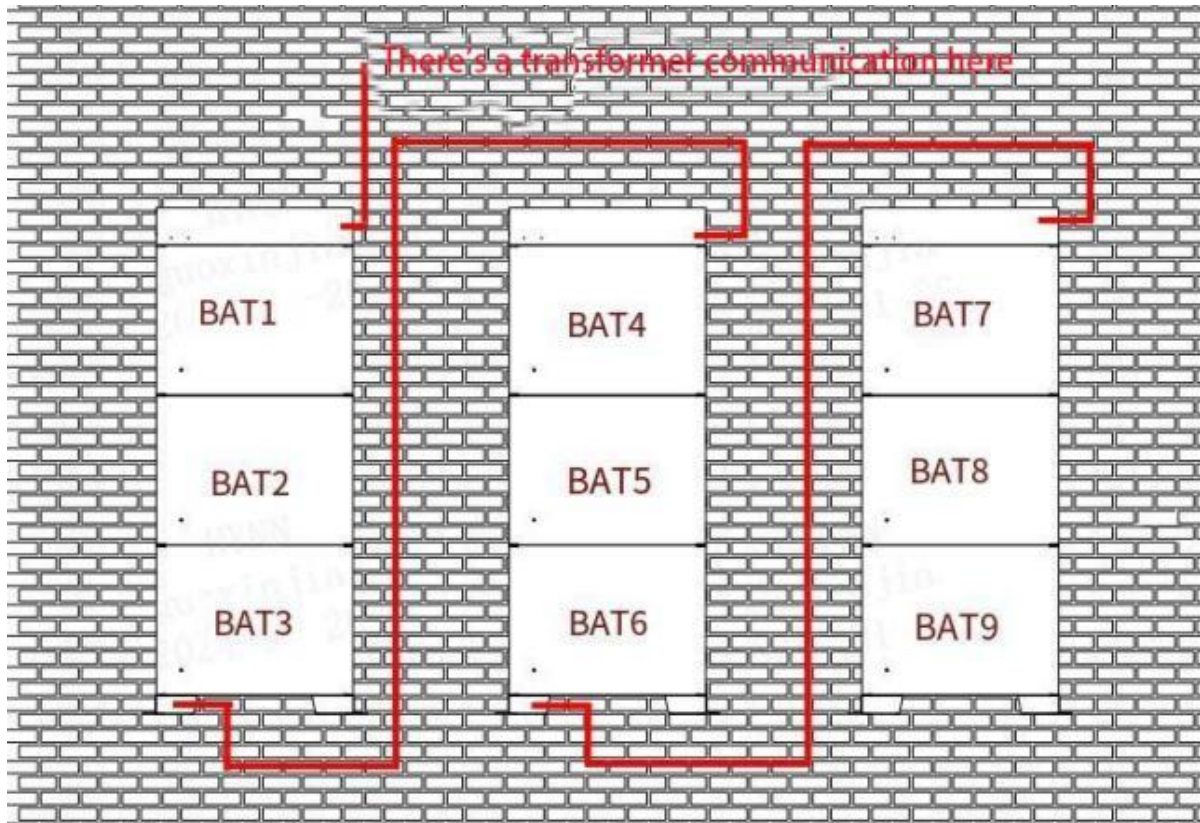
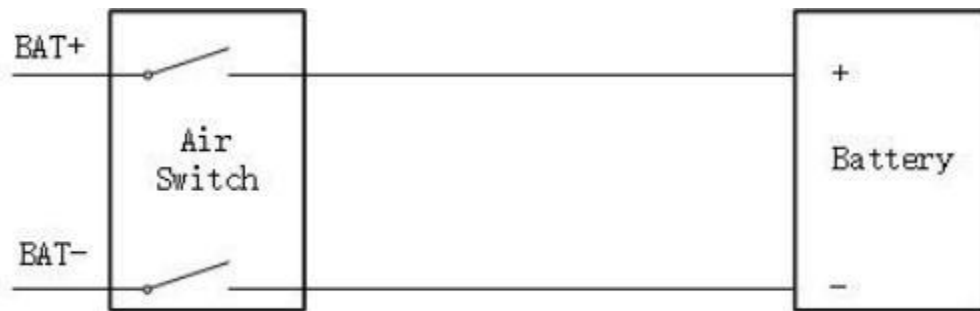

Figure 2-4

3. Product Maintenance Information

3.1 Wiring of the Isolation Device



Important Note: The connection diagram displayed above illustrates the air switch configuration within the device. This installation has already been completed prior to delivery, so no additional onsite connections are necessary.

- One end of the isolation device is connected to the **positive** and **negative terminals** of the battery cell.
- The other end connects to the **BAT+** and **BAT-** terminals of the battery pack (**PACK**)

Isolation device:



BMS protection board:



Battery:



3.2 Monitoring

The device uses RS232 for communication and comes with software provided by the manufacturer. After installation, connect the RS232 communication cable to the device's communication terminal, then double-click the file located in the red box to run the software.

Config	2024/2/21 16:14	Folder
BmsTools (2).zip	2024/2/21 16:14	ZIP zip file
BmsTools.exe	2024/2/21 16:14	Applications
BmsTools.exe.config	2024/8/17 9:02	XML Configurati...
BmsTools.zip	2024/2/21 16:13	ZIP file

The following page is displayed after the software is opened. You need to click the red box to properly communicate with the device.

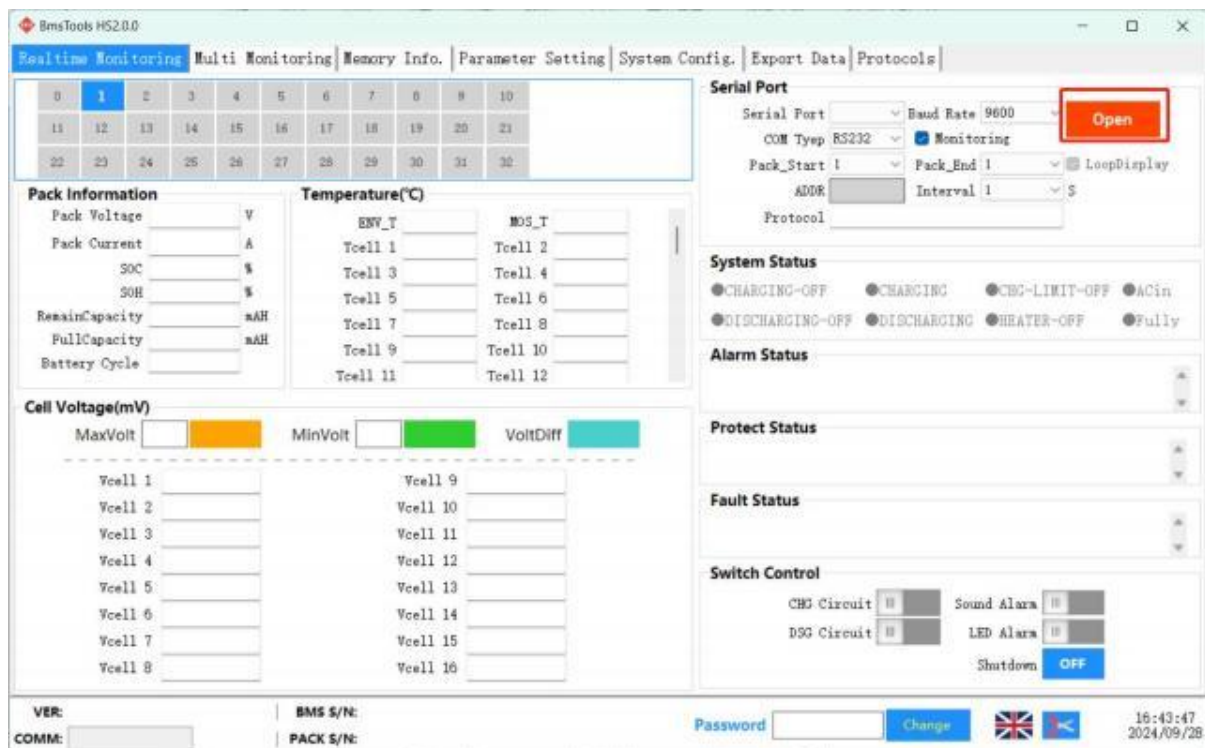

The screenshot shows the BmsTools HS2.0.0 software interface. The 'Serial Port' section on the right has an 'Open' button highlighted in a red box. The interface displays various battery monitoring parameters and controls.

Once the communication between the device and the software is disconnected, the device's protection function remains unaffected. The monitoring software is intended for use by technical personnel to diagnose battery faults and is not accessible to users. Daily monitoring of the device requires coordination between the device and a compatible inverter. The PACK uploads data to

the inverter, allowing users to view both historical and real-time data of the PACK via the inverter's display screen or an app. If the device encounters an issue, the built-in buzzer will sound a warning, and you should promptly contact technical personnel for maintenance.

Note: The monitoring software allows language switching through the Settings menu. For more details, please refer to Attachment 1: BMS Tools Operation Instructions.

3.3 Device Protection Function

Protection Mechanism				
Charge-Discharge	Protection Program	Protection Limit	Delayed	Restorability Y/N
Charge	Single Overcharge Protection	3650mv	1.0s	Y
	Overall Overcharge Protection	56.8v	1.0s	Y
	Charge Overcurrent Protection	130a	1.0s	Y
	Maximum Temperature Protection	115°C	\	Y
	Cell Low Temperature Protection	-5	\	Y
	Cell High Temperature Protection	60°C	\	Y
	Single Over discharge Protection	2700mv	1.0s	Y
	Overall Over discharge Protection	44v	1.0s	Y

Discharge	Discharge Overcurrent 1 Protection	130a	1.0s	Y
	Discharge Overcurrent 2 Protection	≥150a	100ms	Y
	Maximum Temperature Protection	115°C	\	Y
	Cell Low Temperature Protection	-5	\	Y
	Cell High Temperature	60°C	\	Y

3.4 Maintenance and Cleaning Information

Regular maintenance of the battery system will prolong its lifespan and ensure it meets the necessary design specifications. Following proper maintenance procedures will facilitate the assessment of the battery's health and help determine if a replacement is needed, as well as assist in identifying any system faults.

Device Operation:

- **Starting the Device:** To turn on the device, simply press the button located on the side and set the isolation device to the "ON" position.
- **Stopping the Device:** To turn off the device, press the side button again and switch the isolation device to the "OFF" position.

Note: When the button is flush, the device is off. When the button is concave, the device is on.

Maintenance procedure:

1. **Clean the Shell:** Wipe the device shell with a dry rag to ensure it is free from vermin and debris.
2. **Check Isolation Device:** Ensure the isolation device is operating below 125A.
3. **Inspect Cables:** Check the positive and negative cables for damage, starting from the plug at the output end and extending to the other end of the cable. If any damage is found, contact our after-sales service hotline immediately.
4. **Examine Nameplate:** Ensure the device nameplate is clearly visible. If it is blurred or scratched, contact our after-sales service hotline.
5. **Check Ventilation:** Inspect the vent for foreign matter obstructing airflow. If debris is present, attempt to clean it with tweezers or a brush. If it cannot be cleaned, contact our after-sales service hotline.

6. **Monitor Battery Health:** Use the communication cable provided to connect to the pre-installed software on your computer and check the battery's health. If an abnormal condition is detected, a red box will appear in the voltage information bar. Contact our after-sales service hotline immediately.
7. **Inspect the Device Shell:** Check for any damage or deformation on the device shell. If any faults are found that are not caused by human error, contact our after-sales service hotline as soon as possible.
8. **Check for Alarms:** Look for any alarms on the device. If the safe range is exceeded during charging or discharging, refer to section 3.3 (Device Protection Function) in the installation manual. A buzzer will sound a warning alarm. Contact our after-sales service hotline immediately.
9. **Test Fan Operation:** When the device is powered on, hold your hand about 5cm away from the air outlet to feel for normal fan operation. If the fan is not running when it should be or continues to run after the device is shut down, these are anomalies. Contact our after-sales service hotline immediately.
10. **Inspect Output Terminal:** Visually check the output terminal for any deformation, discoloration, or corrosion. If any issues are found, contact our after-sales service hotline immediately.
11. **Safety Data Sheet (SDS) Update:** We will update the Safety Data Sheet (SDS) every 5 years. For inquiries, visit the company's website: www.innoenergy.com.au. If the report is overdue or abnormal, please contact our after-sales service hotline, or via email at service@innoenergy.com.au.

Personal Protective Equipment (PPE) Required for Maintenance Personnel:

- a) **Gloves:** PVC fabric base for enhanced protection.
- b) **Anti-Arc Clothing:** Specialized clothing designed to provide safety against arc flash hazards.

